

VL LO+ 00 52

fapim
design

VENICE BABY



LOIRA



**VENICE
VENICE TOP**



HORUS

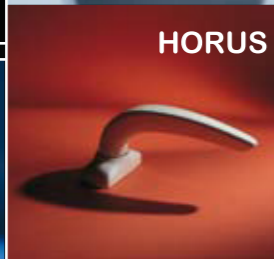

FLORENCE



NEFER



**TITAN
ATLAS**



DOMATIC



PANAMA



GALIPLUS2

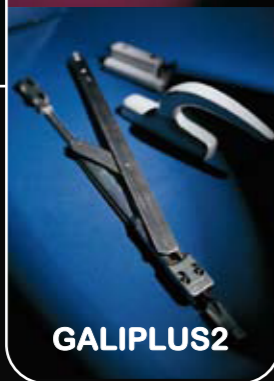

fapim

Fapim s.p.a.
Via delle Cerbaie, 114
55011 Altopascio (LU) Italia
Tel. ++39 0583 - 2601 Fax ++39 0583 -25291
http://www.fapim.it e-mail: info@fapim.it

fapim
BENELUX

Fapim Benelux s.p.r.l.
Avenue Rue St. Roch, 17 7712
Herseaux Belgium
Tel. ++32 - 56 - 340548 Fax ++32 - 56 - 341960
e-mail: info@fapimbenelux.be

fapim
POLSKA

Fapim Polska Sp.zo.o.
J.Pilsudskiego 200
05-270 Marki Polonia
Tel. ++48 227813797 Fax. ++48 227811022
e-mail: info@fapim.pl

fapim
HISPANIA

Fapim Hispania S.L.
C/Edison, esq Ingeniero
Goicoechea, 74 Poligono Industrial Torreherro
Talavera De La Reina (TOLEDO)
Tlf. ++34 925 - 828357 Fax: ++34 925 - 841148
administracion@fapimhispania.com
pedidos@fapimhispania.com

fapim
MIDDLE EAST

Fapim MIDDLE EST FZE
Post Box No. 120814, Q3-131 Sharjah International
Airport Freezone (SAIF ZONE) Sharjah United Arab Emirates
Tel No.: 06-5578210 Fax No. 06-5578211
fapim@emirates.net.ae

fapim
RUSSIA

Fapim Ru LLC
249010, Dom 33, Kievskoe Shosse,
Obrninsk, Kaluga region Russian Federation
Tel.: +79163116480

DOMATIC

Domatic s.r.l.
Via Chimenti
55011 Altopascio (LU) Italia
Tel. ++39 0583 - 216603 Fax ++39 0583 -216604
http://www.domatic.it e-mail: info@domatic.it

fapim®
www.fapim.it



LOIRA® +

G B F D N L R U S



Micrometric adjustment in the three directions, when the door is in the closed position.
 Réglage micrométrique à porte fermée dans les trois directions.
 Mikrometrischen Verstellung in drei Richtungen mit geschlossenen Tür.
 Micrometrische afstelling in de drie richtingen met gesloten deur.
 Микрометрическая регулировки по трем направлениям.



Tested up to 160 Kg – 1.000.000 cycles
 Testée jusqu'à 160 Kg – 1.000.000 cycles
 Getestet für 160 kg – 1.000.000 Zyklen
 Getest 160 Kg – 1.000.000 cyclussen
 Протестирована на 160 кг - 1 000 000 циклов

Body in extruded aluminium.
 Corps de aluminium extrudé
 Bandteil in strangpress Aluminium
 Lichaam in extrusie aluminium
 Корпус из экструдированного алюминия.

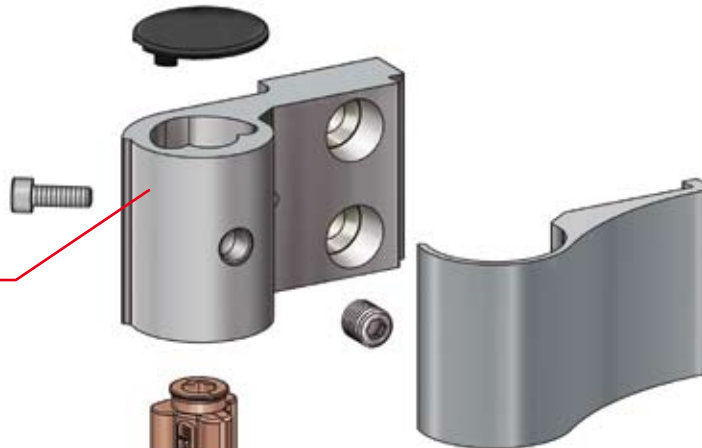

Bush in zamak, pre-assembled on rectified stainless steel pin.
 Douille de zamak, pré-montée sur l'axe en acier inox rectifiée
 Zamak Buchse, vormontiert auf der rektifiziertem Edelstahlbolze
 Zamak bus, voorgemonteerd op de gerectificeerde roestvrij stalen as met
 Втулка из металлического сплава, в нее уже установлена высокоточная ось из нержавеющей стали.

Pre-positioning device in nylon.
 Dispositif de nylon de pré-positionnement.
 Positionierung durch Nylon Gerät
 Voorpositionering door middel van nylon inrichting
 Установлено пластиковое кольцо, определяющее нулевое положение

Anti-theft system.
 Système antieffraction
 Einbruchhemmend system
 Inbraakwerend systeem
 Противовзломные функции.

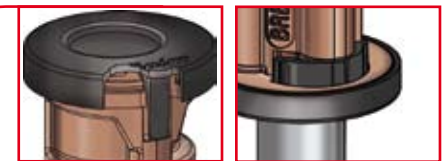

Bush in zamak, with Delrin anti-friction device.
 Douille de zamak avec insert en Delrin antieffraction.
 Zamak-Buchse mit Reibungshemmende Komponenten in Delrin
 Zamak bus met wrijvingloze componenten in Delrin.
 Втулка из металлического сплава со вставкой из Delrin, имеющая антифрикционные свойства.

Snap-in screw cover plates in extruded aluminium.
 Plaques couvre vis à déclenchement en aluminium extrudé
 Klick Abdeckstück in strangpress Aluminium
 Klik schroefafdekplaten in extrusie aluminium
 Защелкивающиеся наружные крышки выполнены из экструдированного алюминия.

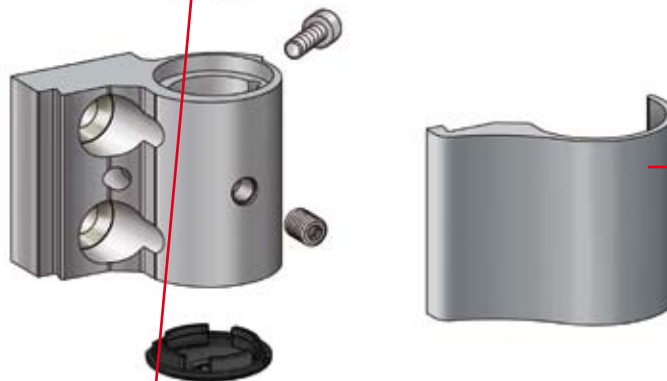



± 2,5 mm



+ 4 mm



0 mm

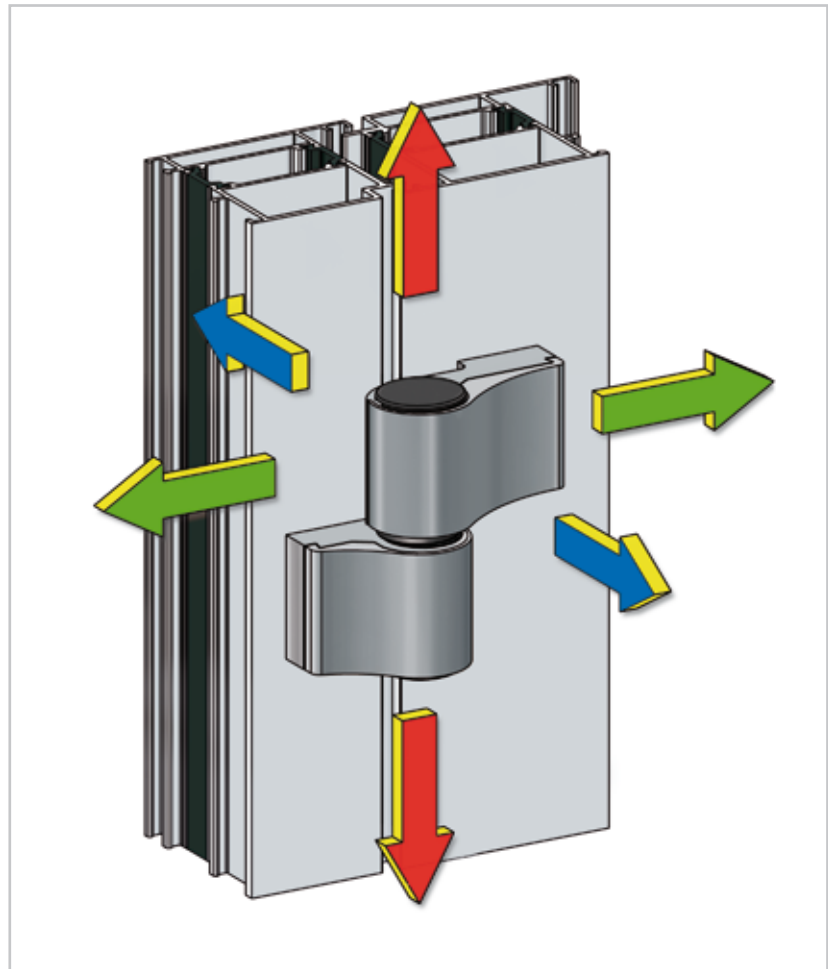

























± 0,5 mm



LOIRA +







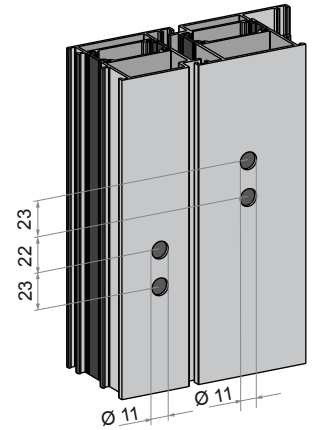
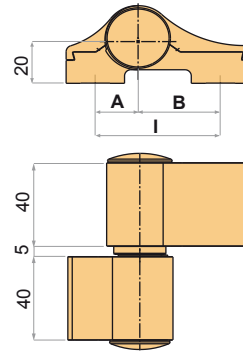
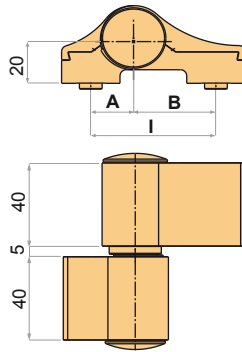



Art.
 7000
 7000i
 7010
 7010i
 7020
 7030
 7040
 7040i
 7050
 7050i
 7060
 7070









Art.	l(mm)	A(mm)	B(mm)
 7000V	60	20,5	39,5
 7000Vi	60	20,5	39,5
 7010V	67	20,5	46,5
 7010Vi	67	20,5	46,5
 7020V	79	39,5	39,5
 7030V	80	20,5	59,5
 7040V	86	39,5	46,5
 7040Vi	86	39,5	46,5
 7050V	93	46,5	46,5
 7050Vi	93	46,5	46,5
 7060V	99	39,5	59,5
 7070V	106	46,5	59,5



LOIRA +



Art.
 7003
 7013
 7013i
 7023
 7033
 7043
 7053
 7063
 7073

Art.	l(mm)	A(mm)	B(mm)
 7003V	60	20,5	39,5
 7013V	67	20,5	46,5
 7013Vi	67	20,5	46,5
 7023V	79	39,5	39,5
 7033V	80	20,5	59,5
 7043V	86	39,5	46,5
 7053V	93	46,5	59,5
 7063V	99	39,5	59,5
 7073V	106	46,5	59,5

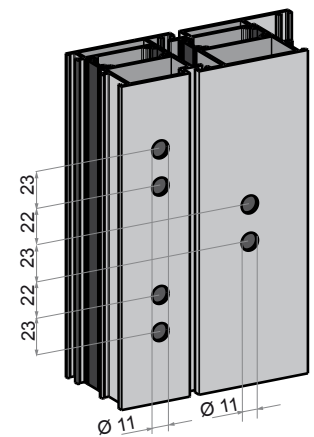
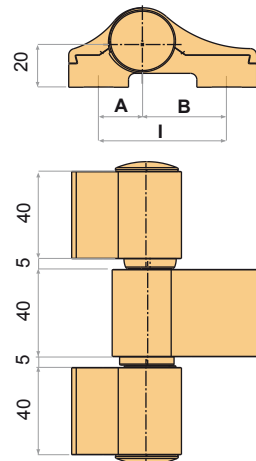
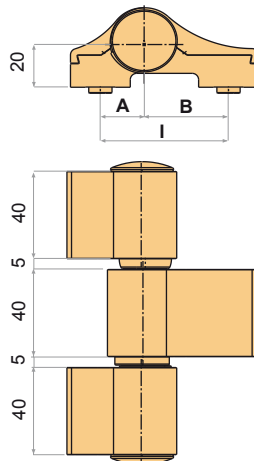

LOIRA +



Art.	l(mm)	A(mm)	B(mm)
7100	53	13,5	39,5
7100i	53	13,5	39,5
7110	60	13,5	46,5

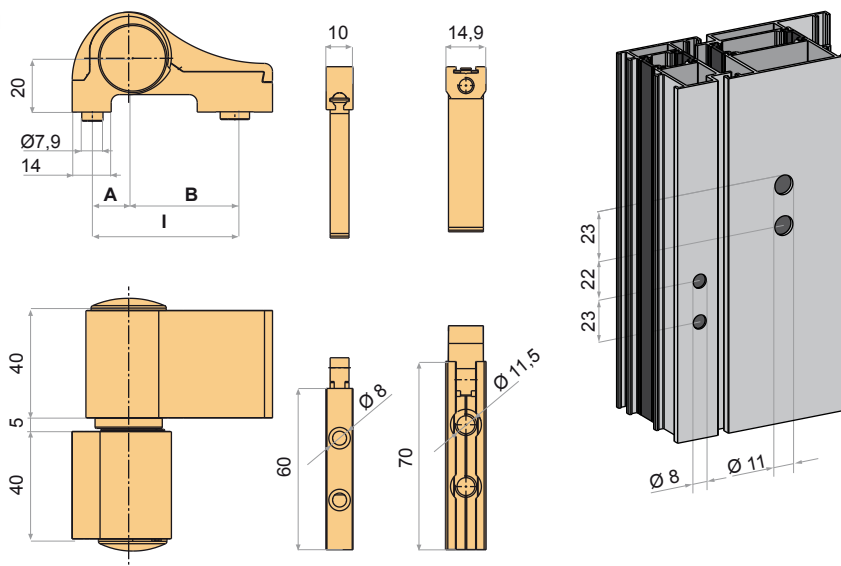

LOIRA +



Art.	l(mm)	A(mm)	B(mm)
7103	53	13,5	39,5

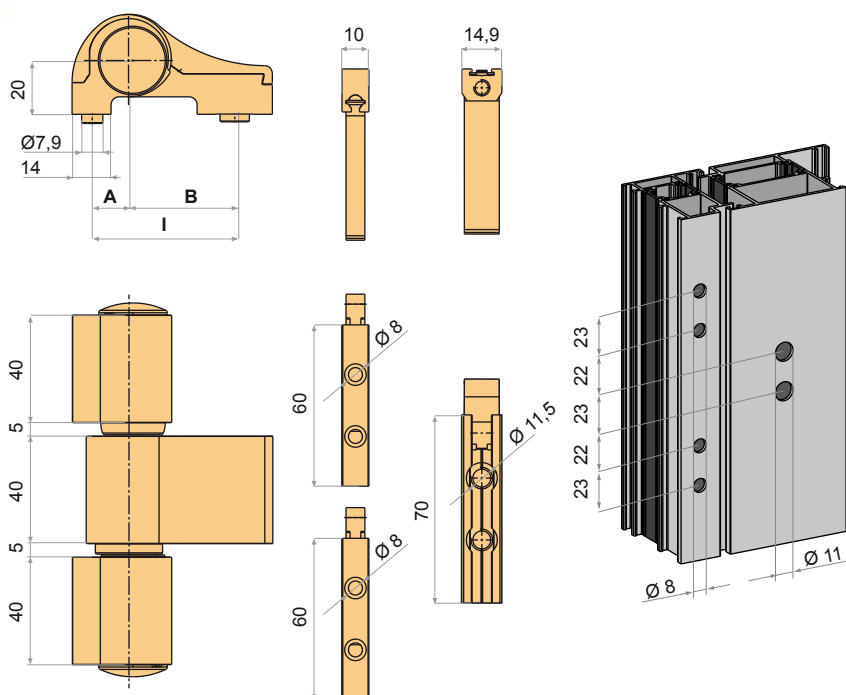

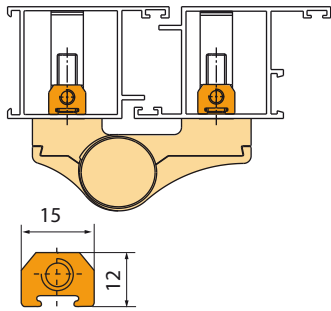

Art.		
6623		
6625		
6665AM		
6665AMi		
6665CM		

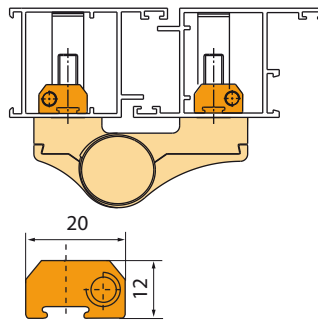

Art.		
6624		
6626		
6665BM		
6665BMi		
6665DM		

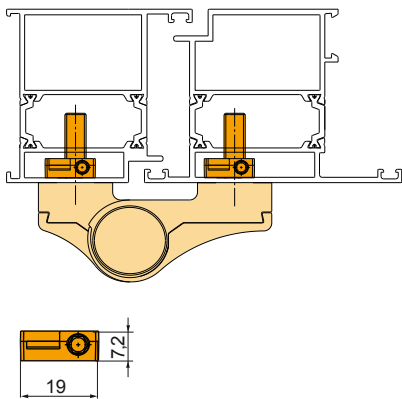

Art.		
6620		
6620i		
6621		
6621i		
6621Ai		

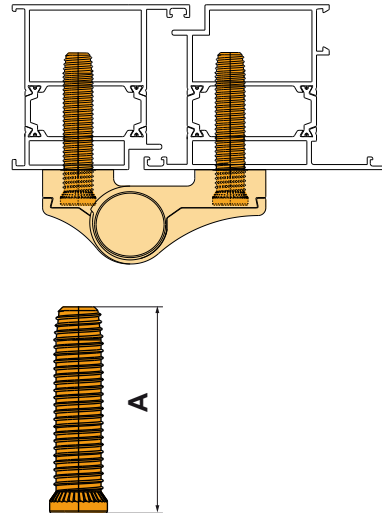

Art.	A		
6603A	50		
6603B	50		
6603AX	50		
6603BX	50		
6603i	50		
6603Xi	50		
6604A	60		
6604B	60		
6604AX	60		
6604BX	60		
6604i	60		
6604Xi	60		

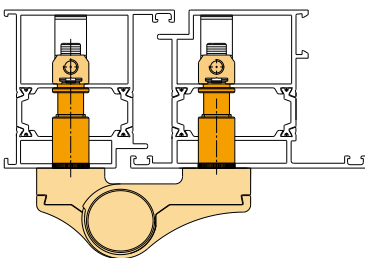

Art.	A	B
6664B	12-15	45
6664BX	12-15	45
6664C	15-18	45
6664CX	15-18	45
6664D	16,5-23	45
6664DX	16,5-23	45
6664E	23-35	60
6664EX	23-35	60
6664F	35-47	60
6664FX	35-47	60

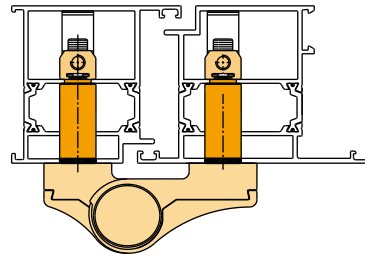

Art.	A	B
6664202	20,2	45
6664238	23,8	45
6664294	29,4	60
6664318	31,8	60

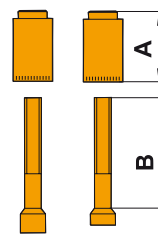
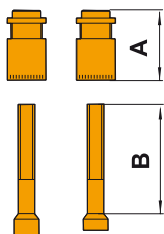



Art.	S
6666s2	2
6666s4	4
6666s5	5
6666s7	7
6666s8	8
6666s8,5	8,5
6666s10	10

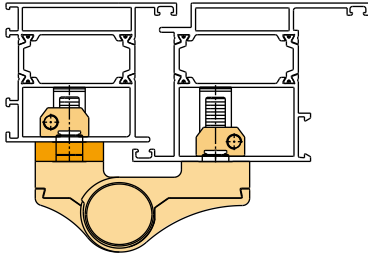

Art.	S
6607A	2
6607B	4
6607C	5
6607D	7
6607E	8
6607F	8,5
6607G	10

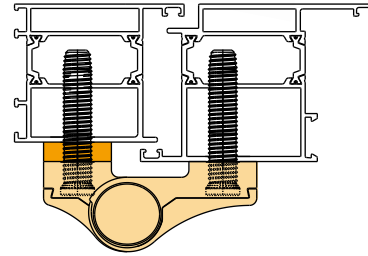

Art.	S
6669s2	2
6669s4	4
6669s5	5
6669s7	7
6669s8	8
6669s8,5	8,5
6669s10	10

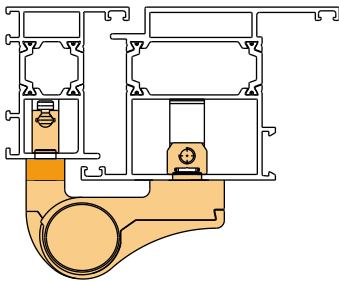

TF-11

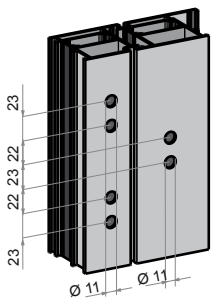
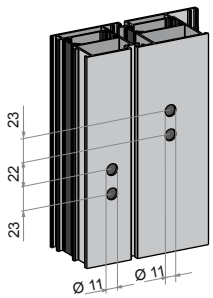

Art.
6885
6885B
6886
6886B

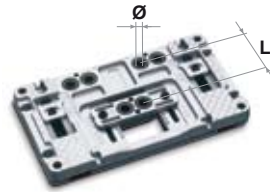

Art.	Ø
6825	11
6825C	15

L = 53-60-67-79-86-93

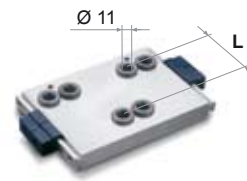

Art.	L
6830A	53
6831	60
6832	67
6832E	73
6833	79
6834	80
6835	86
6836	93
6837	99
6838	106